

PROGRESS OF 4YEARS

*After the Great East Japan
Earthquake & Disaster*

WAZUNIKO WATER NABE
Sendai City Waterworks Bureau

◆ Today's Topic

- 1 Current Status of Affected Areas
- 2 Acceleration on Disaster Prevention Act of SCWB
- 3 Modification of Evacuation Center Operation
in Sendai City

1

CURRENT STATUS OF AFFECTED AREAS

Sendai City
Waterworks Bureau



◆ The Great East Japan Earthquake

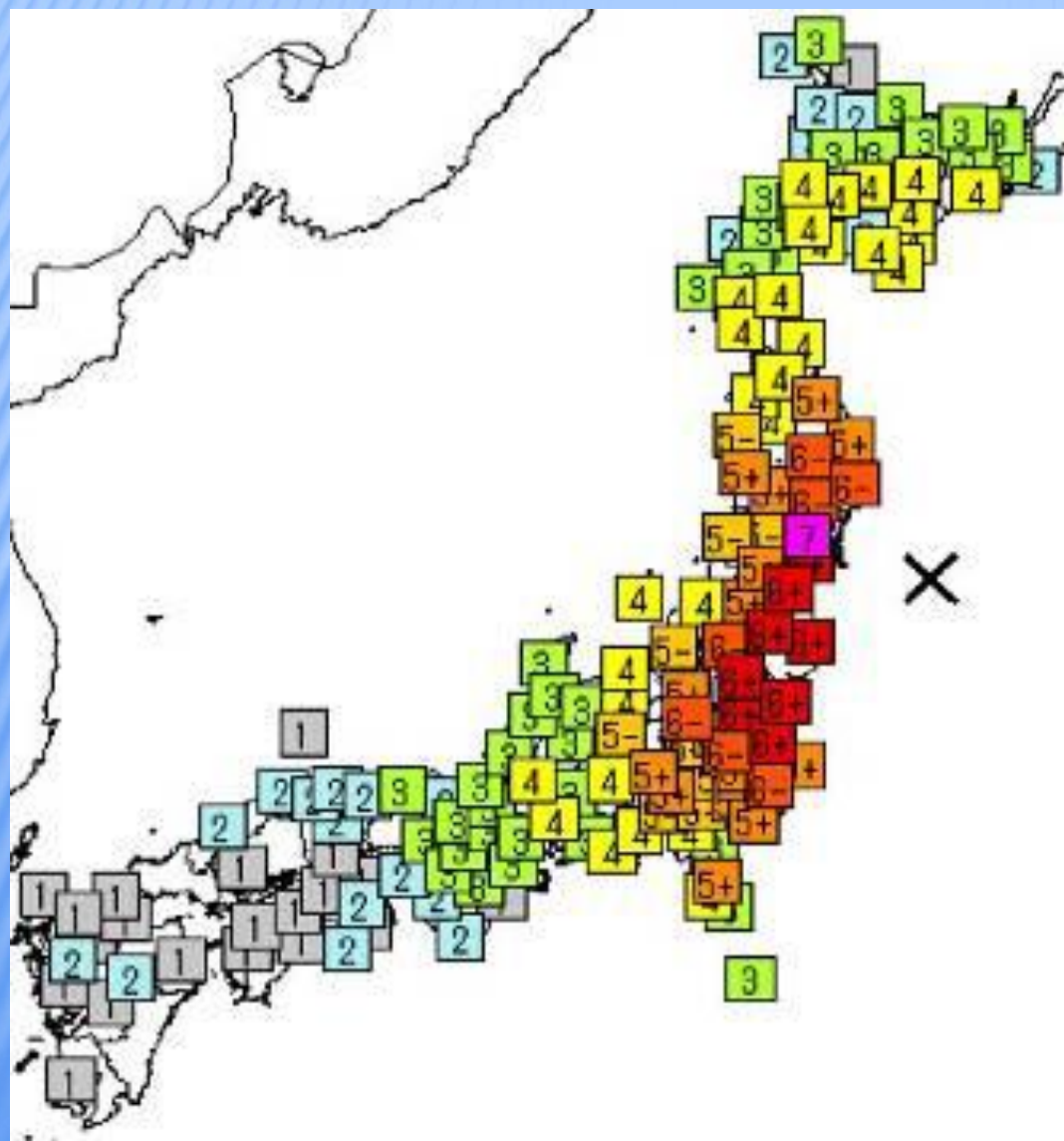

14:46 March 11. 2011

Magnitude 9.0

Maximum Seismic Intensity
Revel 7

◆ TSUNAMI Height

The 2011 Tohoku Earthquake Tsunami
Joint Survey Group

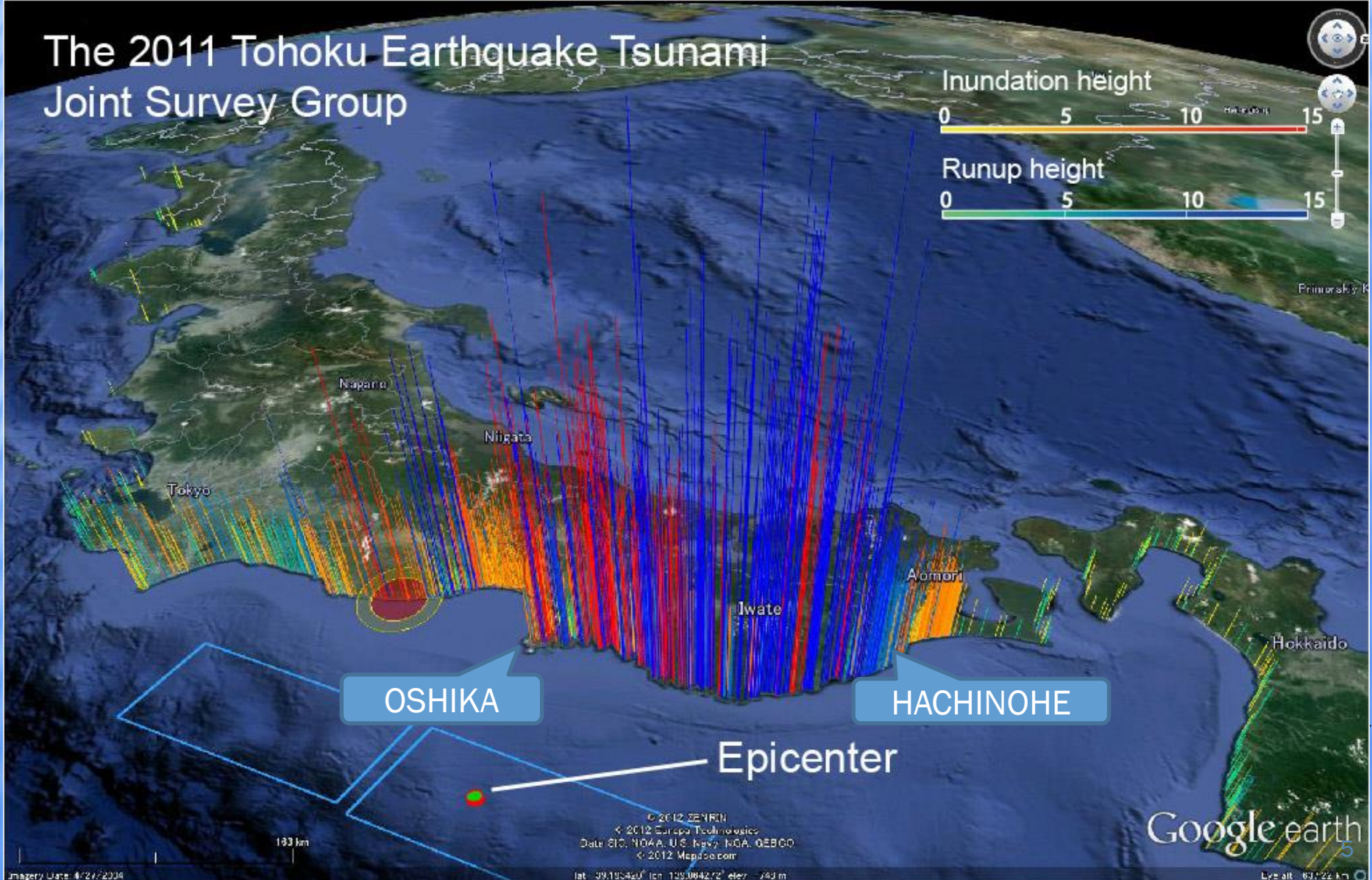

◆ Dead or Missing Number of Victims

平成23年東北地方太平洋沖地震による都道府県別死者・行方不明者数

出典 警察庁緊急災害警備本部広報資料(平成23年7月17日)

- 1人以上10人未満
- 10人以上100人未満
- 100人以上1,000人未満
- 1,000人以上10,000人未満
- 10,000人以上

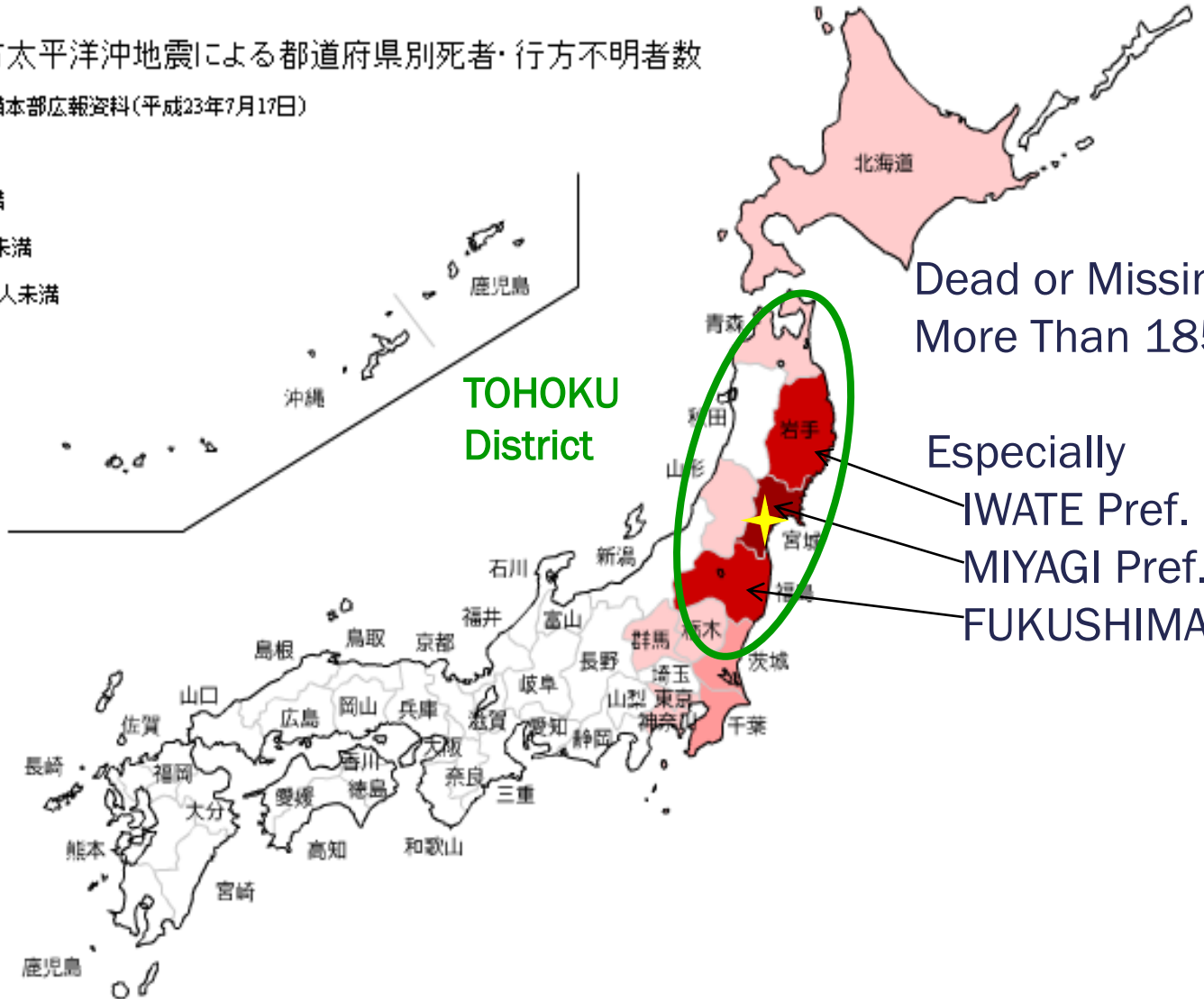

Dead or Missing
More Than 18500 People

Especially
IWATE Pref.
MIYAGI Pref.
FUKUSHIMA Pref.

◆ RIKUZEN TAKATA City

| Victims | Citizen | City Staff |
|-----------------|---------|------------|
| Population | 24,246 | 421 |
| Dead or Missing | 2,066 | 107 |
| % | 8.5% | 25% |

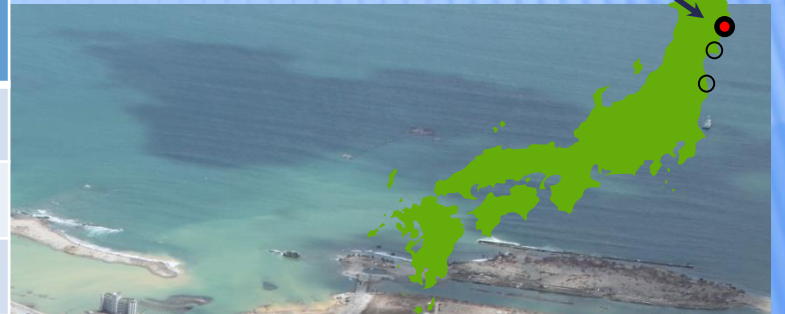

25, May, 2011

平成23年5月25日撮影

Sendai City
Waterworks Bureau

◆ Belt Conveyor

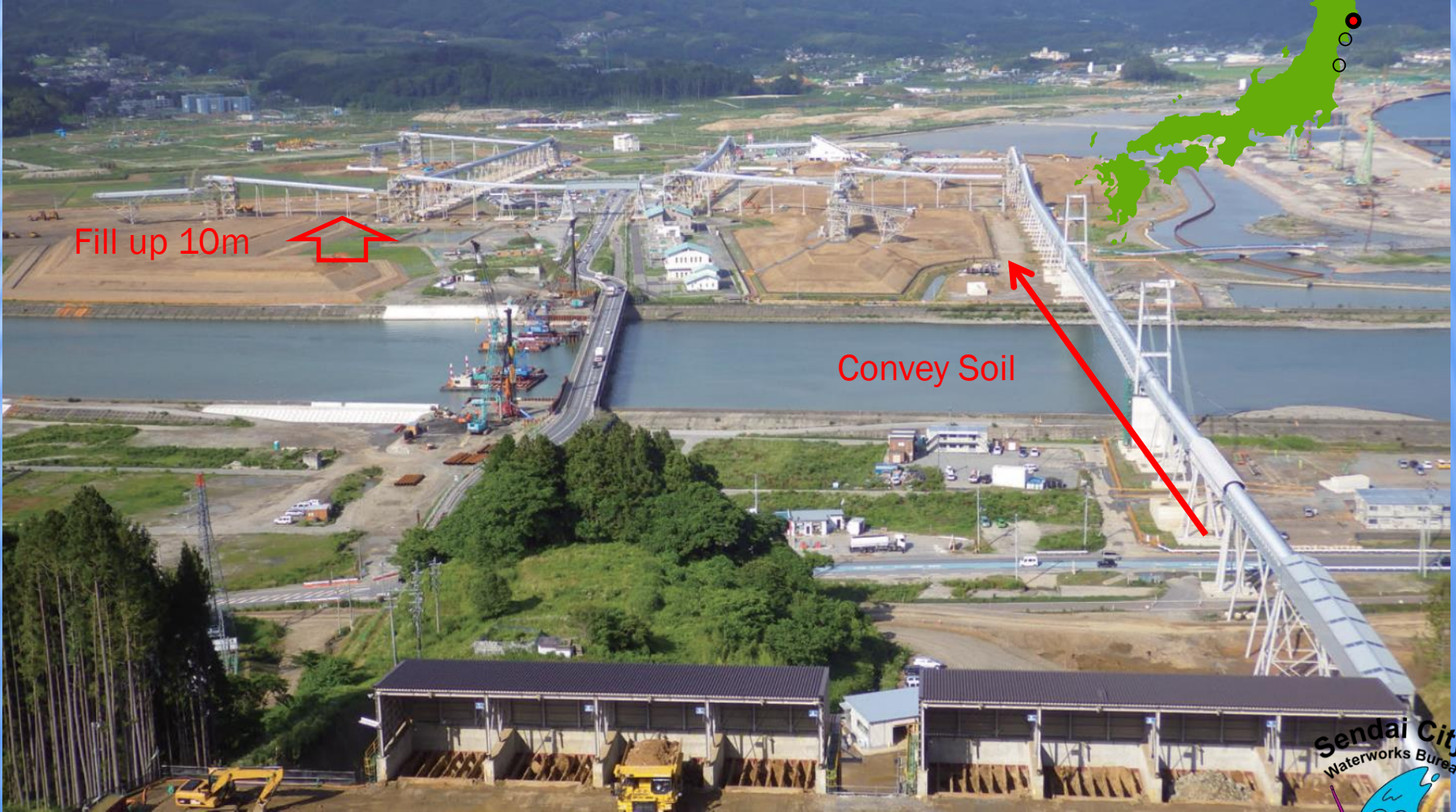

Fill up 10m



Convey Soil



Cut off 80m (120m→40m)



Sendai City
Waterworks Bureau



◆ ISHINOMAKI City



◆ISHINOMAKI City



ISHINOMAKI City Reconstruction Plan

Restoration Stage
Reconstruct Housing, Industrial and Life Infrastructure.

Reconstruction Stage
Recharge Vitality and Increase the Value of the City

Development Stage
Reborn to More Attractive City

Fiscal Year

2011
2012
2013
2014
2015
2016
2017
2018
2019
2020

| 計画期間 | | |
|------|----------------|---|
| 23年度 | 復旧期 H23~H25 | 生活や産業の再生に不可欠な住宅、生産基盤、インフラなどの復旧を行う |
| 24年度 | | |
| 25年度 | | |
| 26年度 | 再生期 H26~H29 | 復旧されたインフラと市民の力を基に、震災に見舞われる以前の活力を回復し、地域の価値を高める |
| 27年度 | | |
| 28年度 | | |
| 29年度 | | |
| 30年度 | 発展期 H30~H32 | 新たな魅力と活力ある地域として生まれ変わり、発展していく |
| 31年度 | | |
| 32年度 | | |

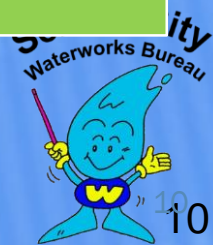

◆HEBITA purification plant



Liquefaction



Sedimentation Basin



Row water Conduit



Pumping Station



Foundation Pile



◆ SUEYAMA purification plant

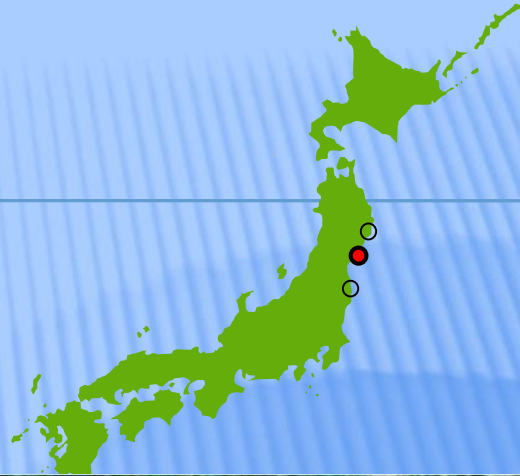

◆ FUTABA County

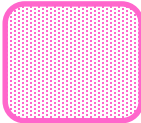
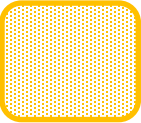
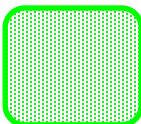
| | |
|--|---|
|  | difficult-to-return zone |
|  | restricted residence area |
|  | zone in preparation for the lifting of the evacuation order |

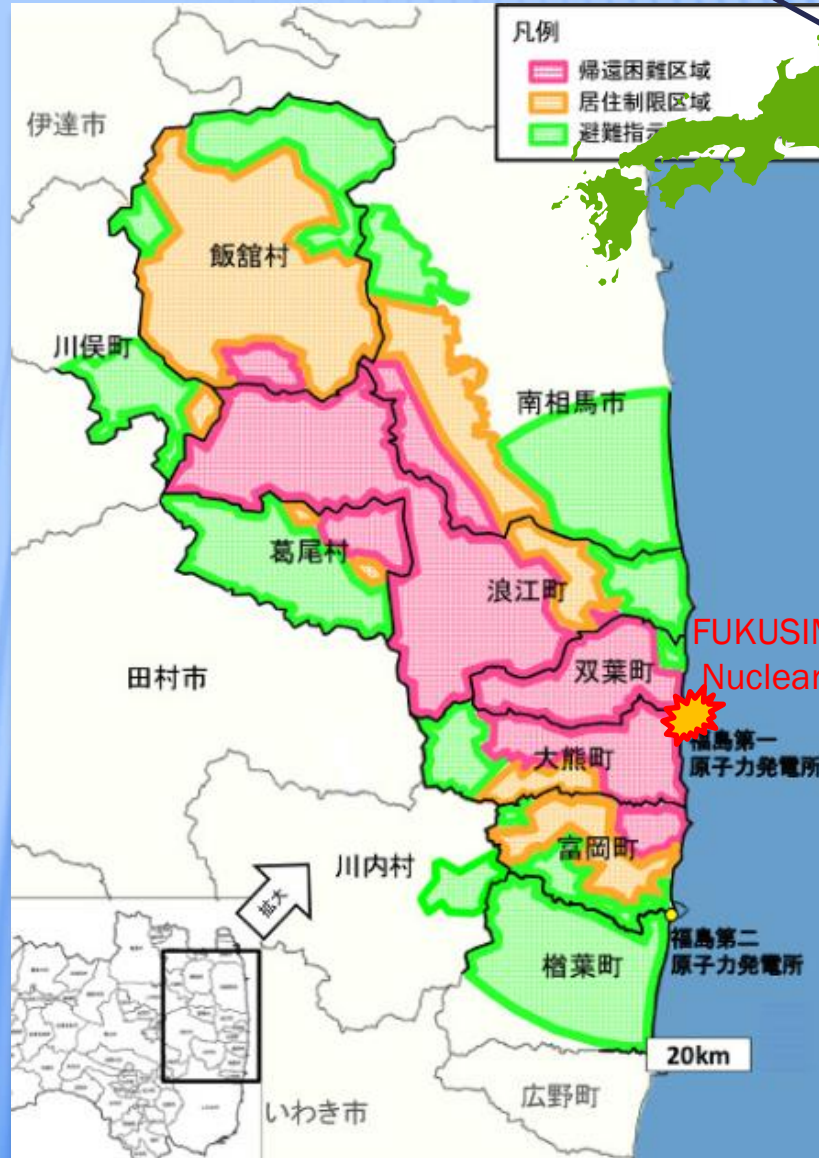

FUKUSIMA No.1 Nuclear Power Plant

福島第一原子力発電所

福島第二原子力発電所

Sendai City Waterworks Bureau



◆ FUTABA County



FUKUSIMA No.1 Nuclear Power Plant



◆ FUTABA County



2 ACCELERATION ON DISASTER PREVENTION ACT OF SCWB

Sendai City
Waterworks Bureau



2 Acceleration on Disaster Prevention Act in SCWB

- PVC Pipeline Renovation
- Dual Transmission System
- Flex Exp. Joint Inspection & Repair Work
- Power Failure Measures
- ER Pipe Laying to Key Medical Institutions
- Temporary Emergency Tap → chapter3

2 Acceleration on Disaster Prevention Act in SCWB

- PVC Pipeline Renovation
- Dual Transmission System
- Flex Exp. Joint Inspection & Repair Work
- Power Failure Measures
- ER Pipe Laying to Key Medical Institutions
- Temporary Emergency Tap → chapter3

ANALYSIS OF PIPELINE DAMAGE

437 leakage repair works on distribution main

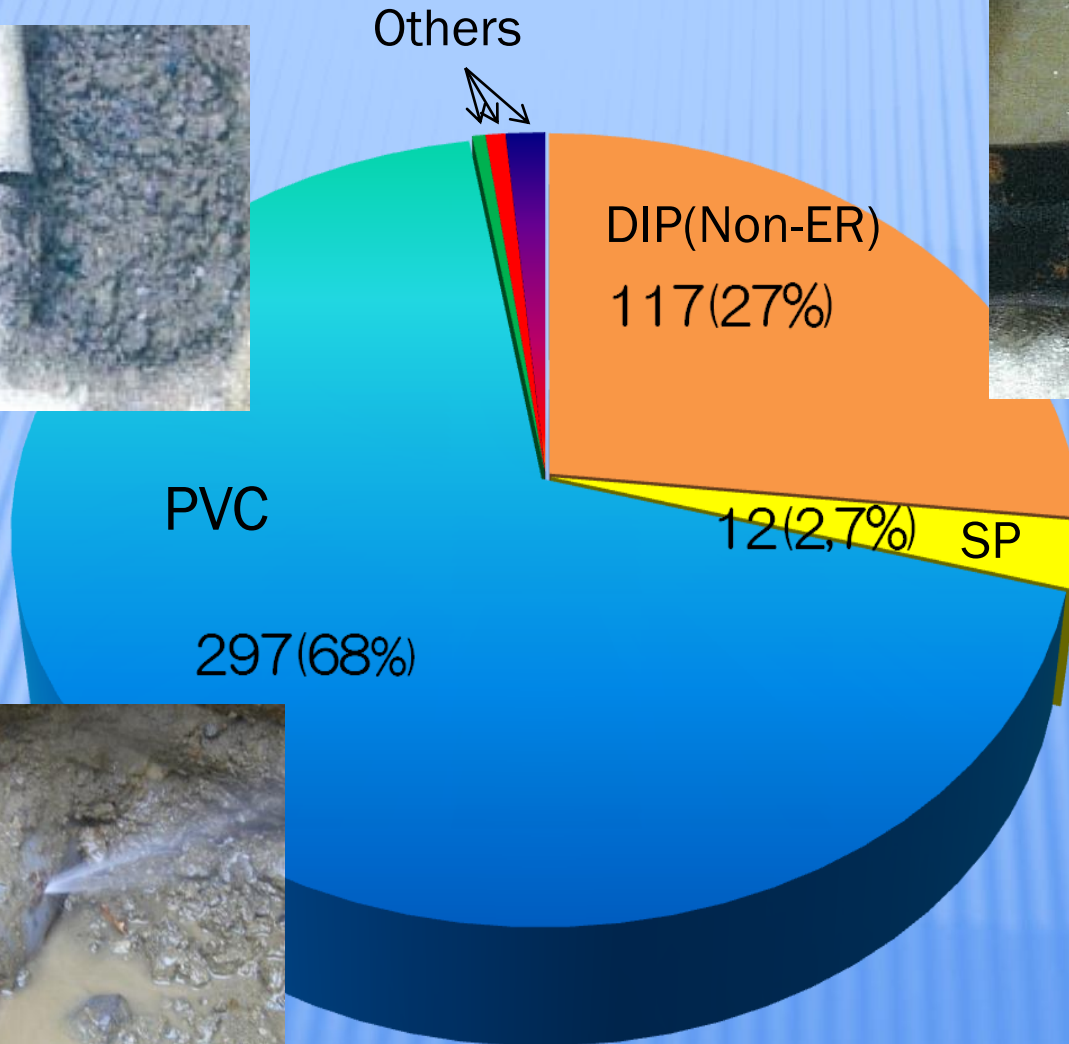

ANALYSIS OF PIPELINE DAMAGE

437 leakage repair works on distribution main

Breakage ratio per KM

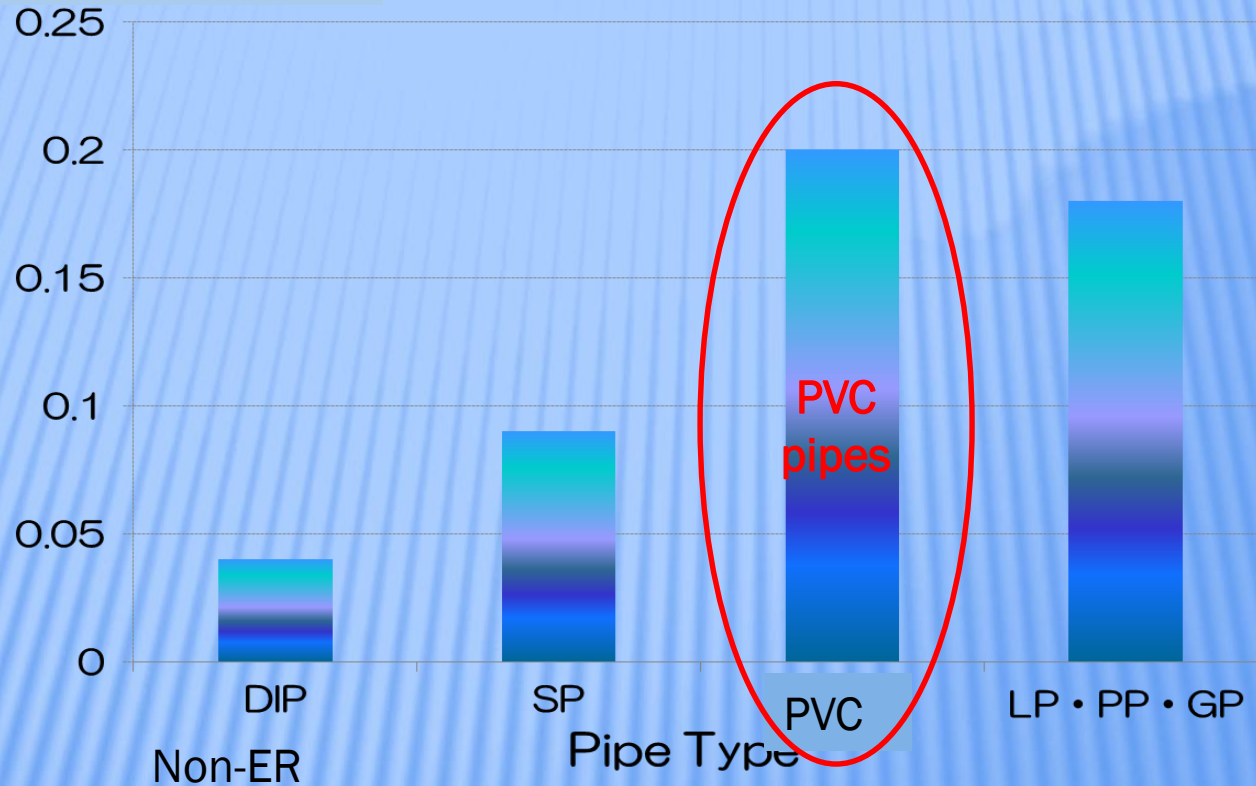

We accelerate pipeline relaying from PVC to ER pipes
8km/year → 14km/year

2 Acceleration on Disaster Prevention Act in SCWB

- PVC Pipeline Renovation
- **Dual Transmission System**
- Flex Exp. Joint Inspection & Repair Work
- Power Failure Measures
- ER Pipe Laying to Key Medical Institutions
- Temporary Emergency Tap → chapter3

Dual Transmission System

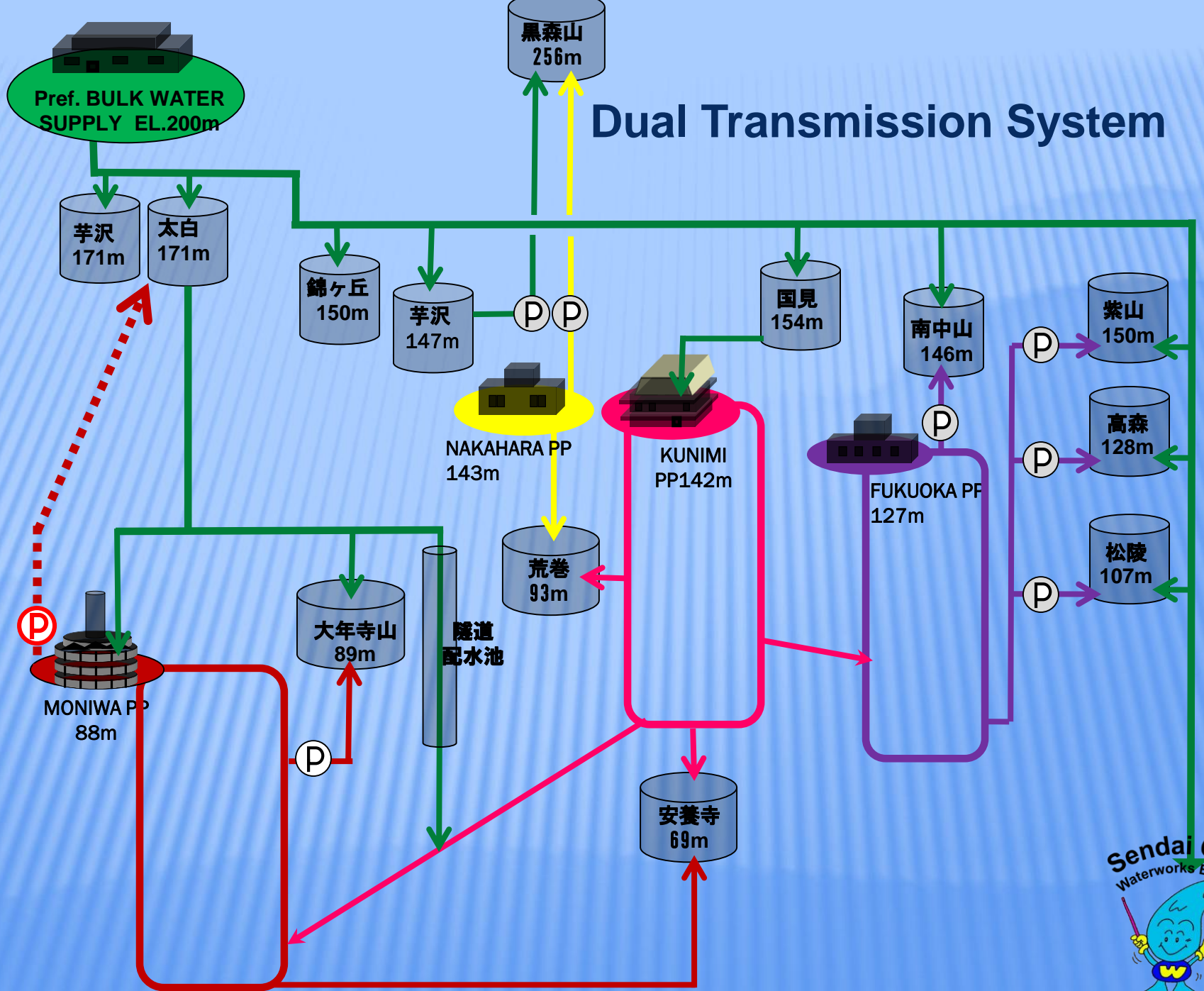

Transmission main $\Phi 2400$ from Prefectural Purification Plant were damaged.

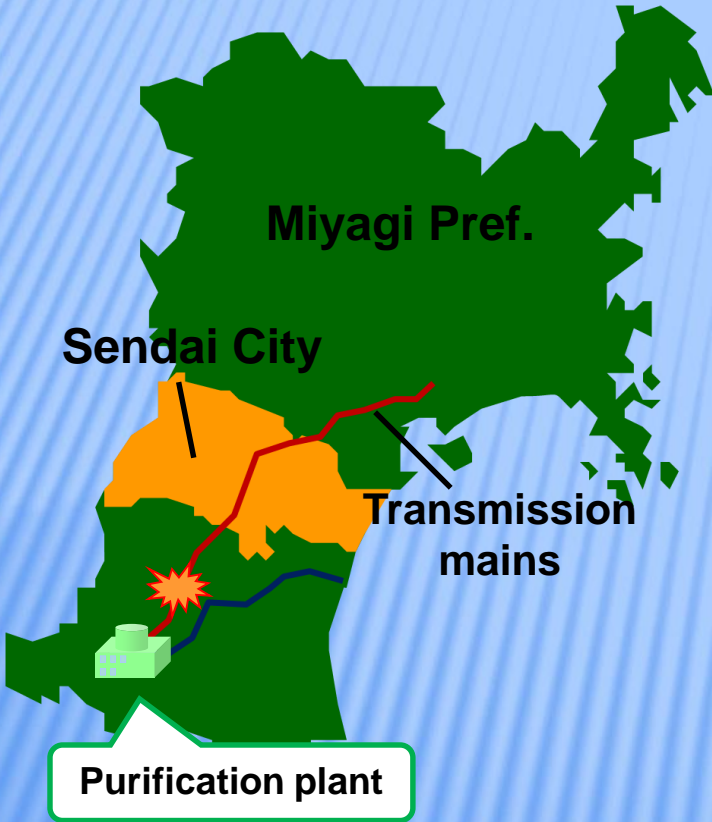

↑ Situation of the leakage and repairing works

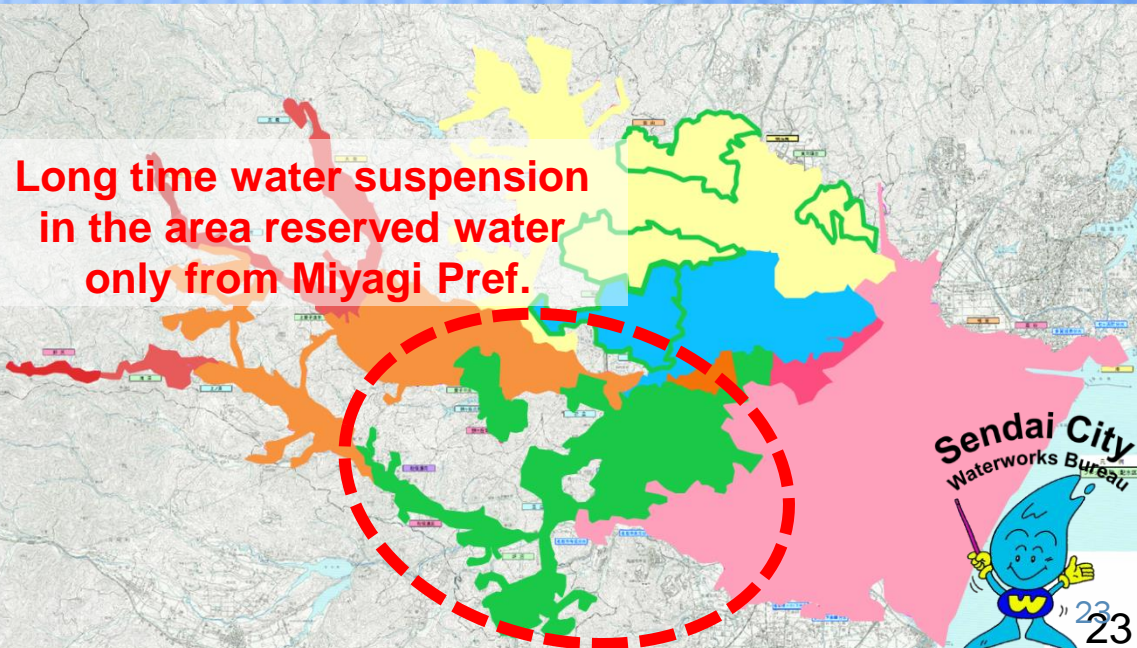

It took **10 days** to recover the water supply for Sendai.

Dual Transmission System

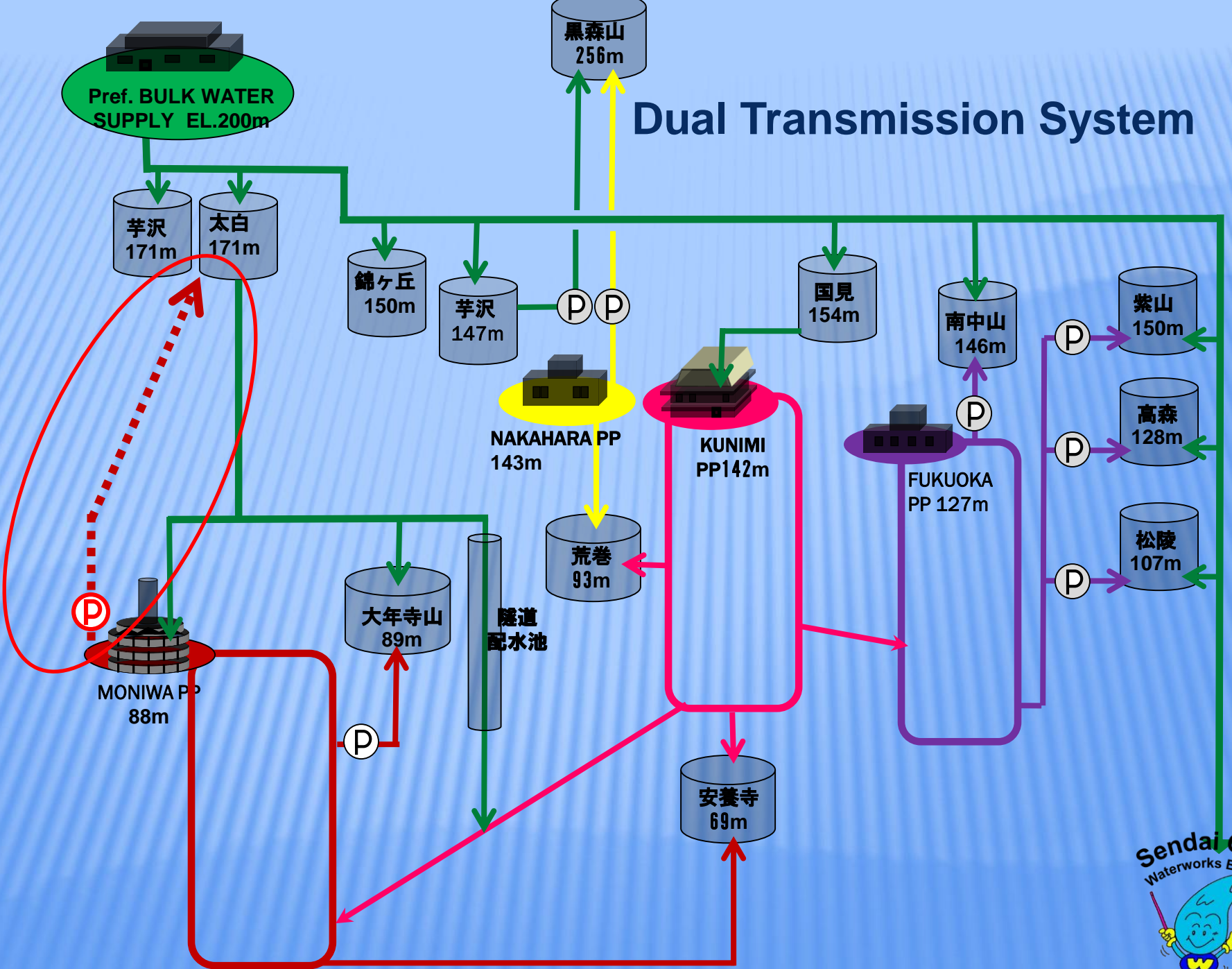

Dual Transmission System

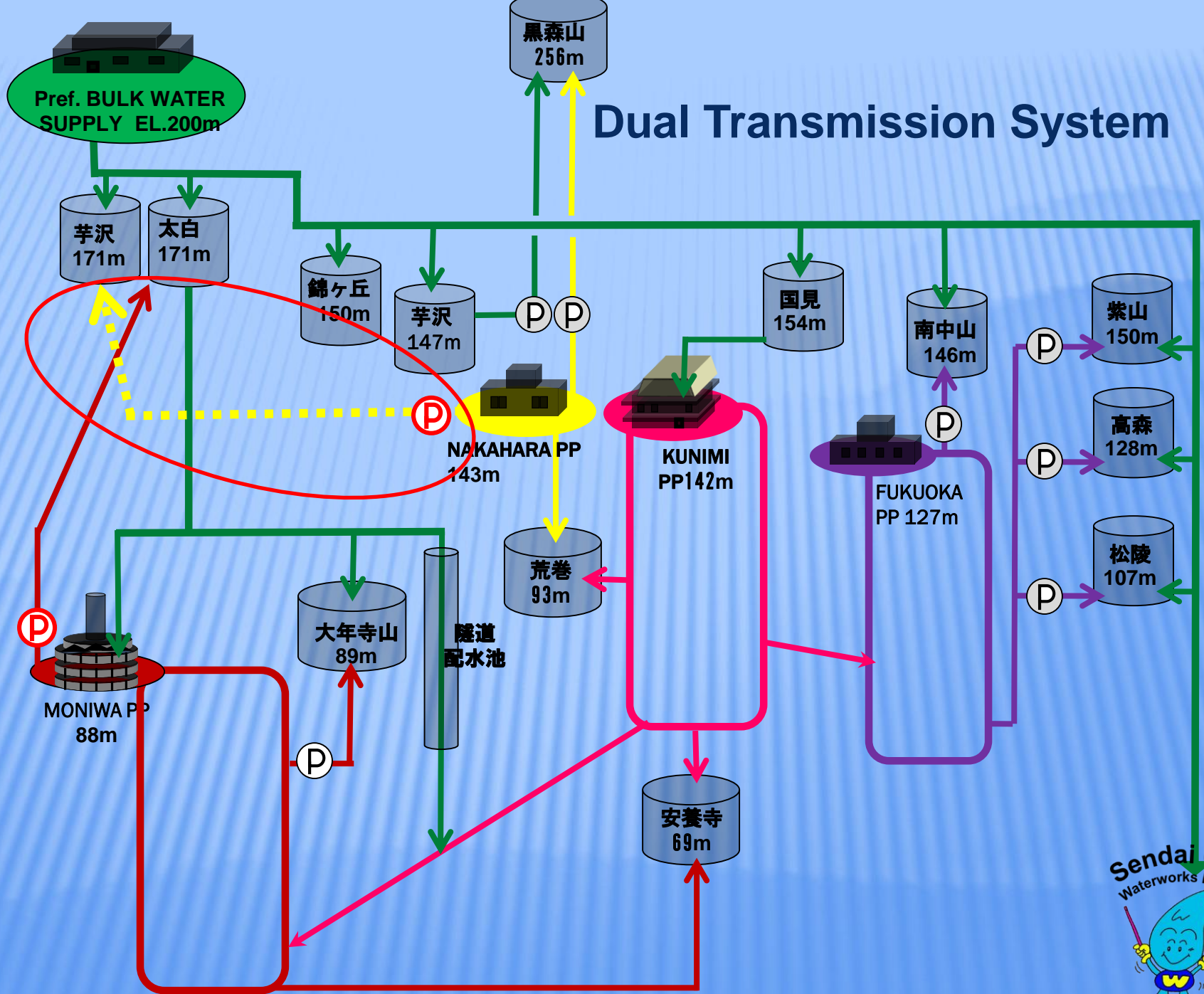

2 Acceleration on Disaster Prevention Act in SCWB

- PVC Pipeline Renovation
- Dual Transmission System
- **Flex Exp. Joint Inspection & Repair Work**
- Power Failure Measures
- ER Pipe Laying to Key Medical Institutions
- Temporary Emergency Tap → chapter3

Flex Exp. Joint Inspection & Repair Work

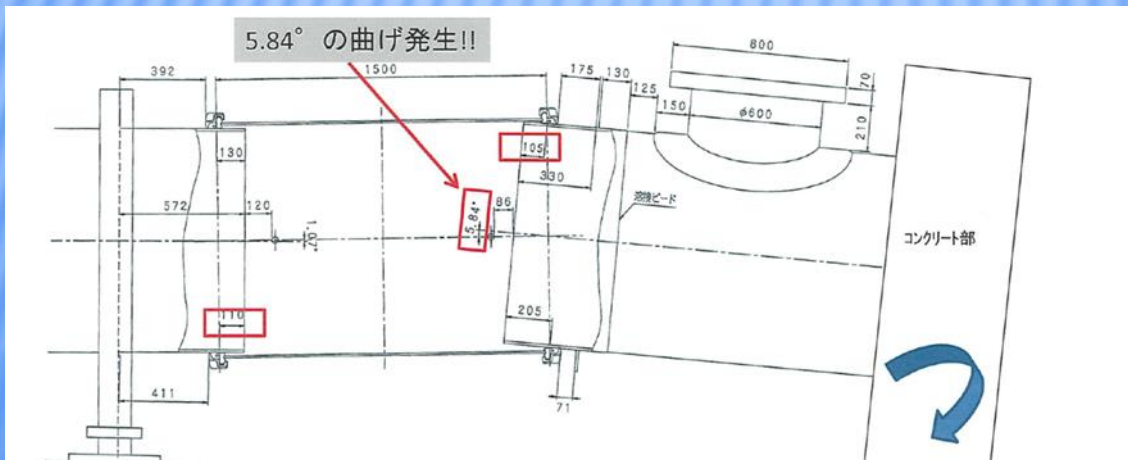

Flex Exp. Joint Inspection & Repair Work

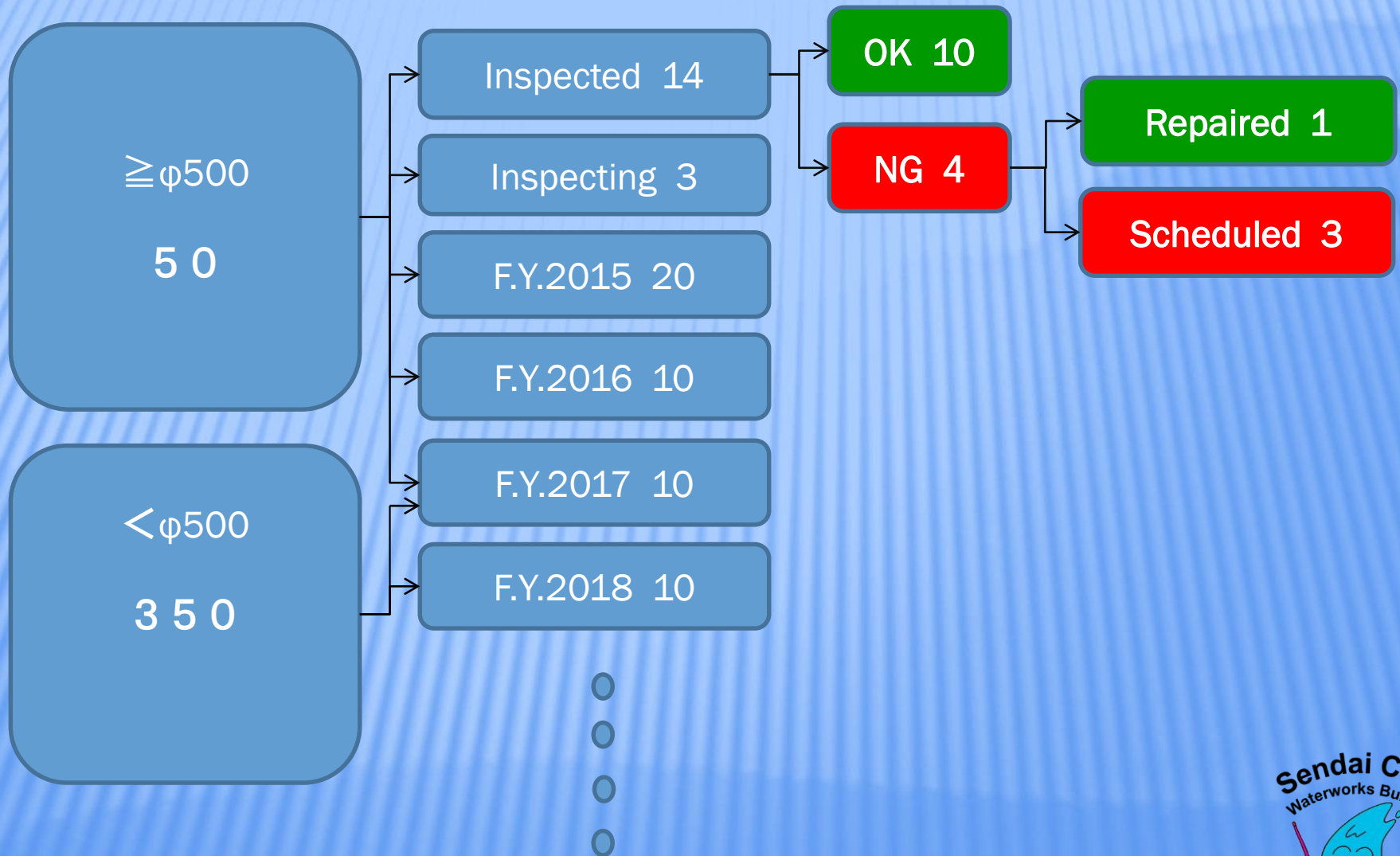

Flex Exp. Joint Inspection & Repair Work

調査結果

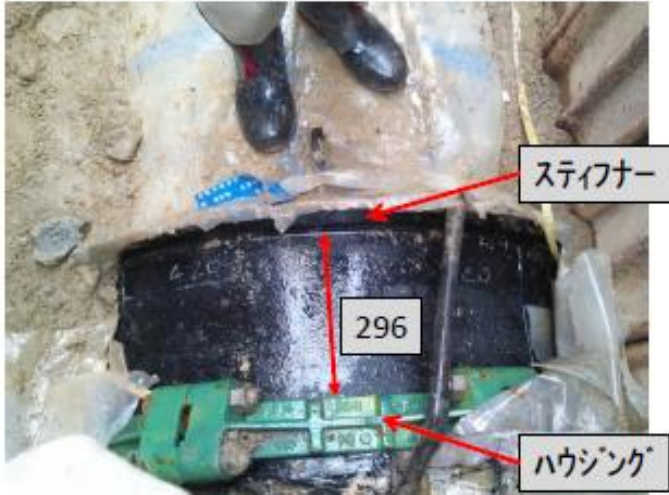

L1側(西側)

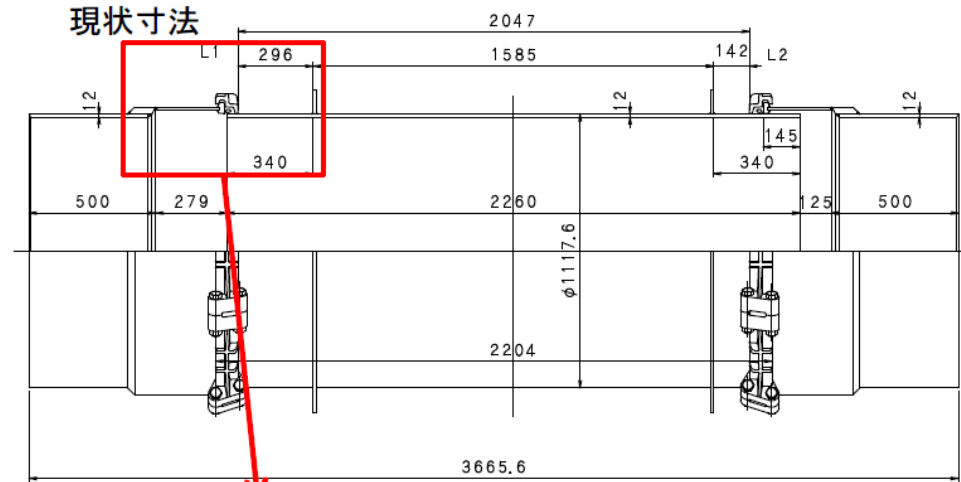

L2側(東側)

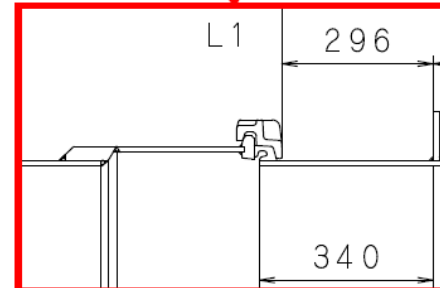

現状は差込がマイナスになっており、ゴムリングが辛うじて引っかかっている状態と思われます。

Designation 140mm → measurement 296mm
It means almost pull out.

通常、ハウジング⇔スティフナー間は140mm程度ですが、今回のL1側は大きく抜けが発生していました。



Flex Exp. Joint Inspection & Repair Work

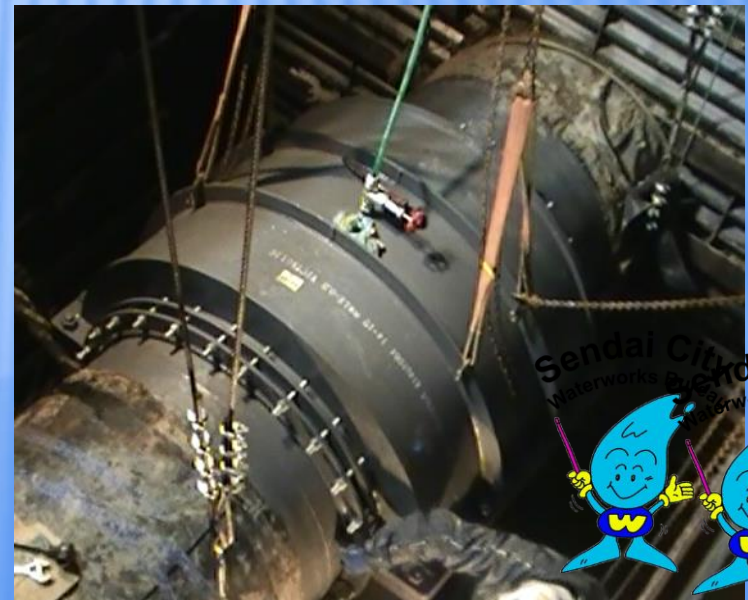

Sendai City
Waterworks Bureau
Waterworks Bureau

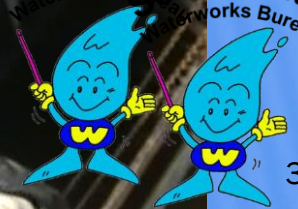

2 Acceleration on Disaster Prevention Act in SCWB

- PVC Pipeline Renovation
- Dual Transmission System
- Flex Exp. Joint Inspection & Repair Work
- **Power Failure Measures**
- ER Pipe Laying to Key Medical Institutions
- Temporary Emergency Tap → chapter3

Power Failure Measures



A line of cars to a gas station

Power Failure Measures

Many small facilities

ABC Purification Plant



Daily Supply

Light Oil for 24Hours generation of DIESEL Engine



We could not deliver.

XYZ Pumping Station

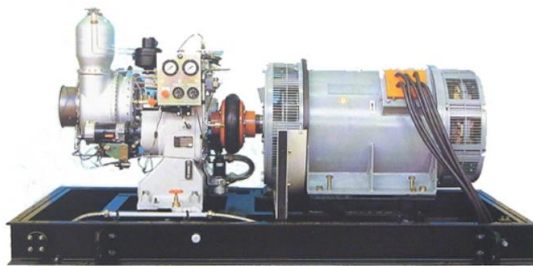

Daily Supply

Kerosene for 24Hours generation of GAS TURBINE Engine



Power Failure Measures

ABC Purification Plant



Light Oil for **72**Hours generation of **DIESEL** Engine

XYZ Pumping Station



Light Oil for **72**Hours generation of **DIESEL** Engine

Many small facilities



Every 3 days supply



Large TANKER

Sendai City
Waterworks Bureau



2 Acceleration on Disaster Prevention Act in SCWB

- PVC Pipeline Renovation
- Dual Transmission System
- Flex Exp. Joint Inspection & Repair Work
- Power Failure Measures
- ER Pipe Laying to Key Medical Institutions
- Temporary Emergency Tap → chapter3

Anxious Function of the Building at a Large Scale Disaster

Q: 大規模災害発生時の 建物機能維持に不安のある部分

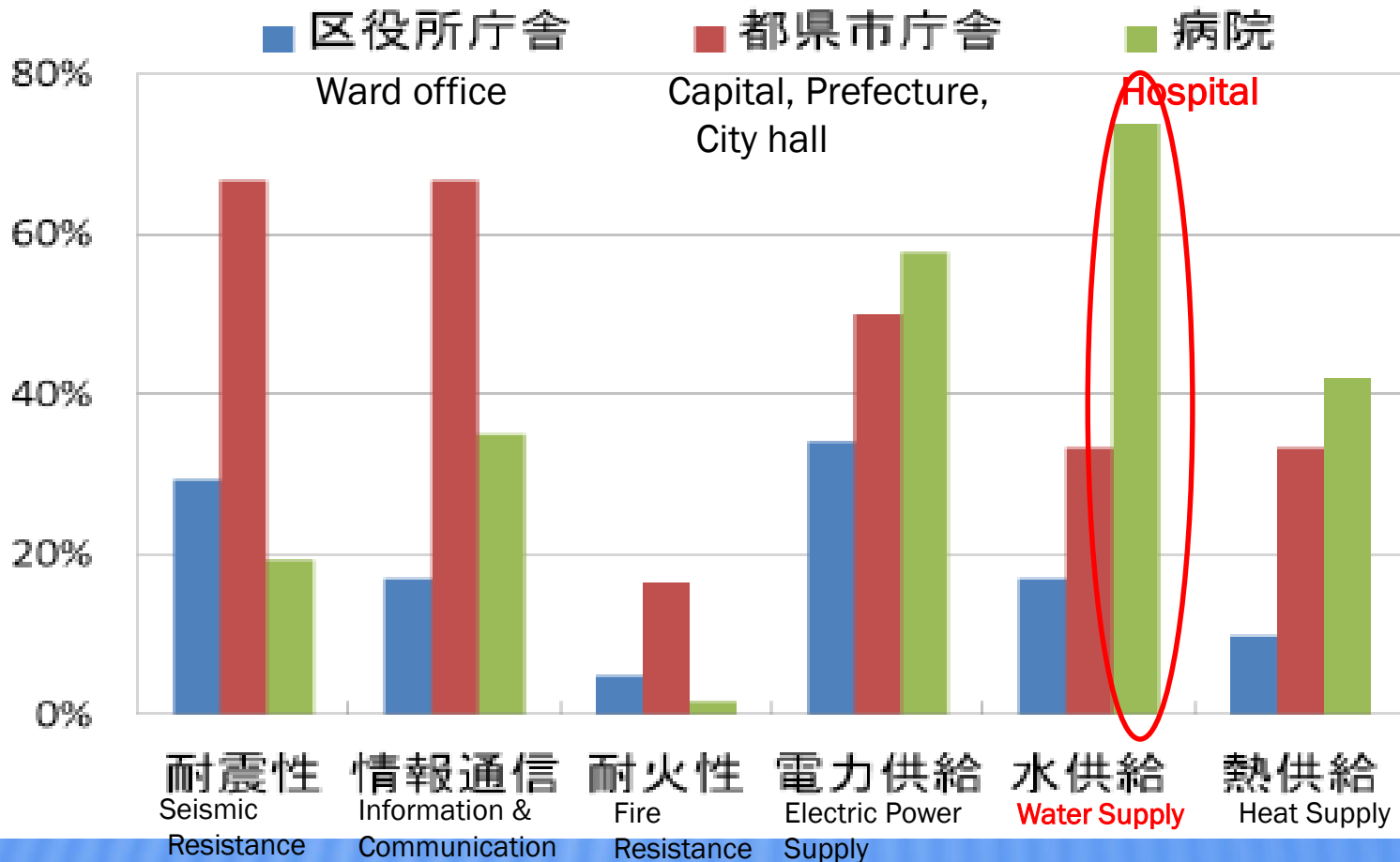

Number of Water Transportation Point



The Great East Japan Earthquake

SENDAI City

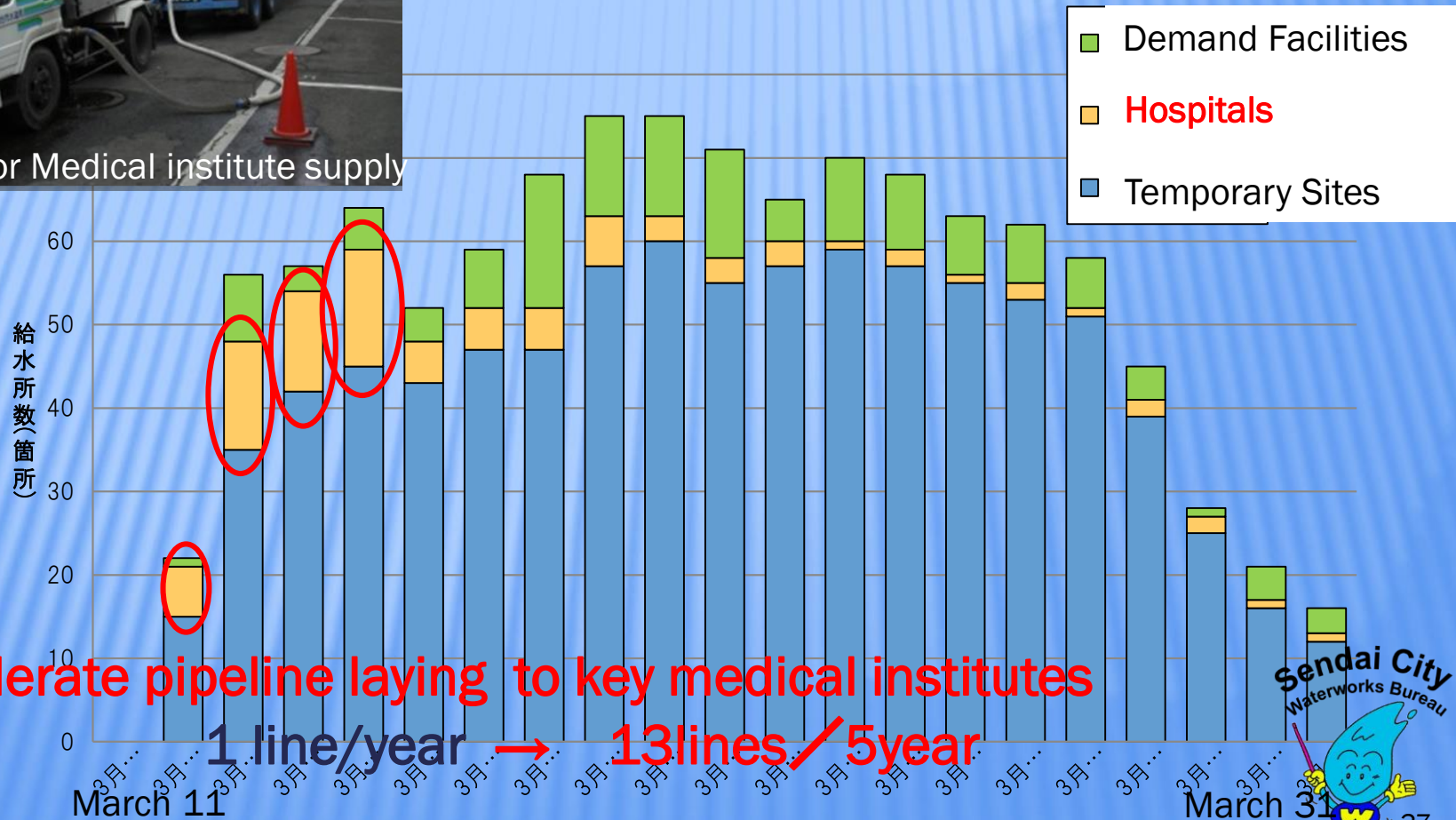

We accelerate pipeline laying to key medical institutes

Sendai City Waterworks Bureau



3 MODIFICATION OF EVACUATION CENTER OPERATION IN SENDAI CITY

Evacuation Centers

At the Great East Japan Earthquake & Disaster

Number of Evacuee

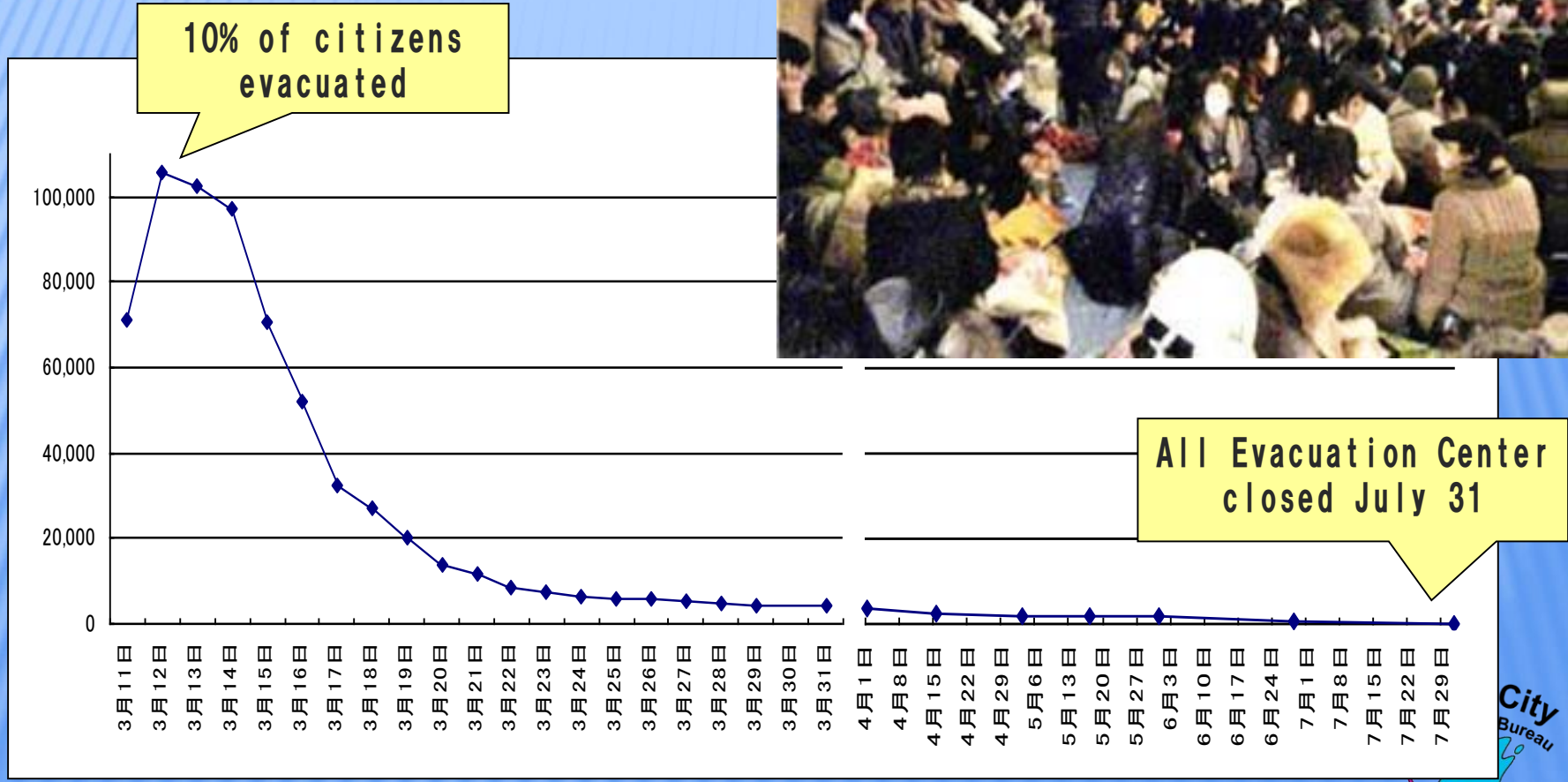

Issues in Operation of Evacuation Centers

At the Great East Japan Earthquake & Disaster

- ✓ Role Assignment and Rulemaking in Evacuation Centers
- ✓ Support Systems by City Staff
- ✓ Consideration for the Differing Needs
Age/Gender/with Pets/etc....

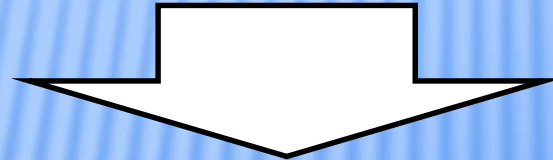

Review of the Evacuation Center Operation

Revised Evacuation Center Operation Manual

○Neighborhood Associations



MUTUAL ASSISTANCE

○Facility Managers



PUBLIC ASSISTANCE

INDIVISUAL SELF-HELP

○Evacuees

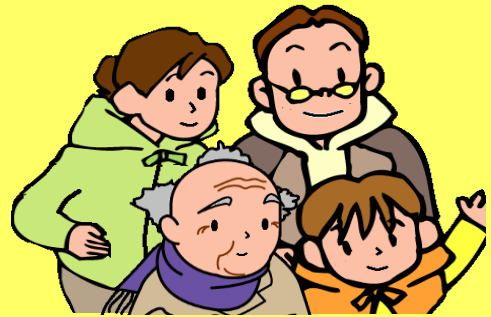

○Assigned City Staff



Preparatory Meeting

○Neighborhood Associations



○Facility Managers

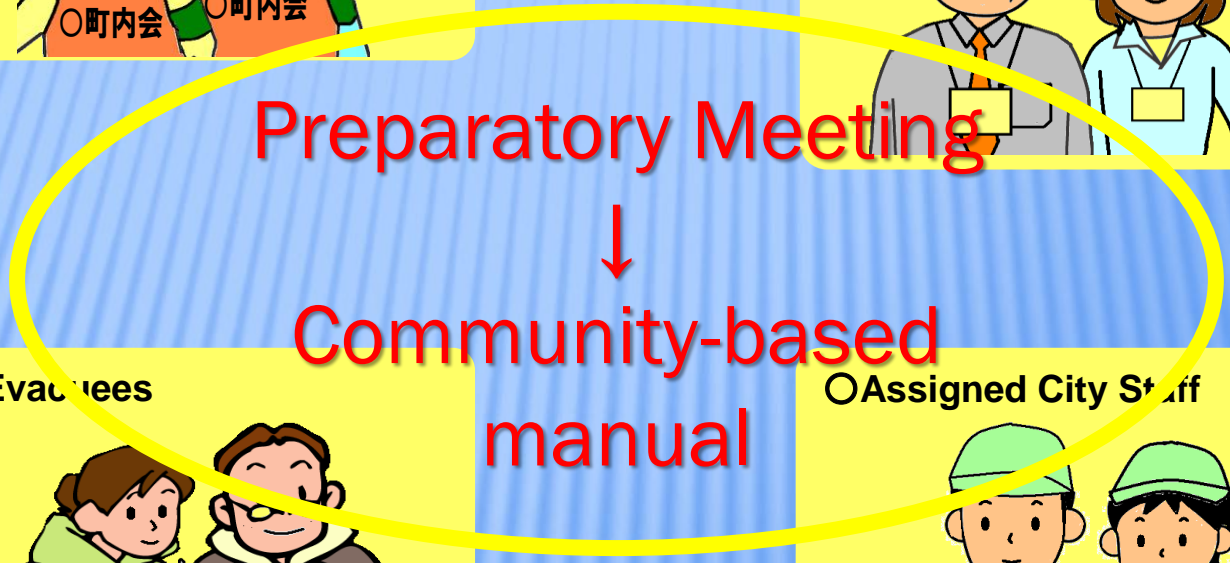

○Evacuees



○Assigned City Staff



Progress Status of Each Community

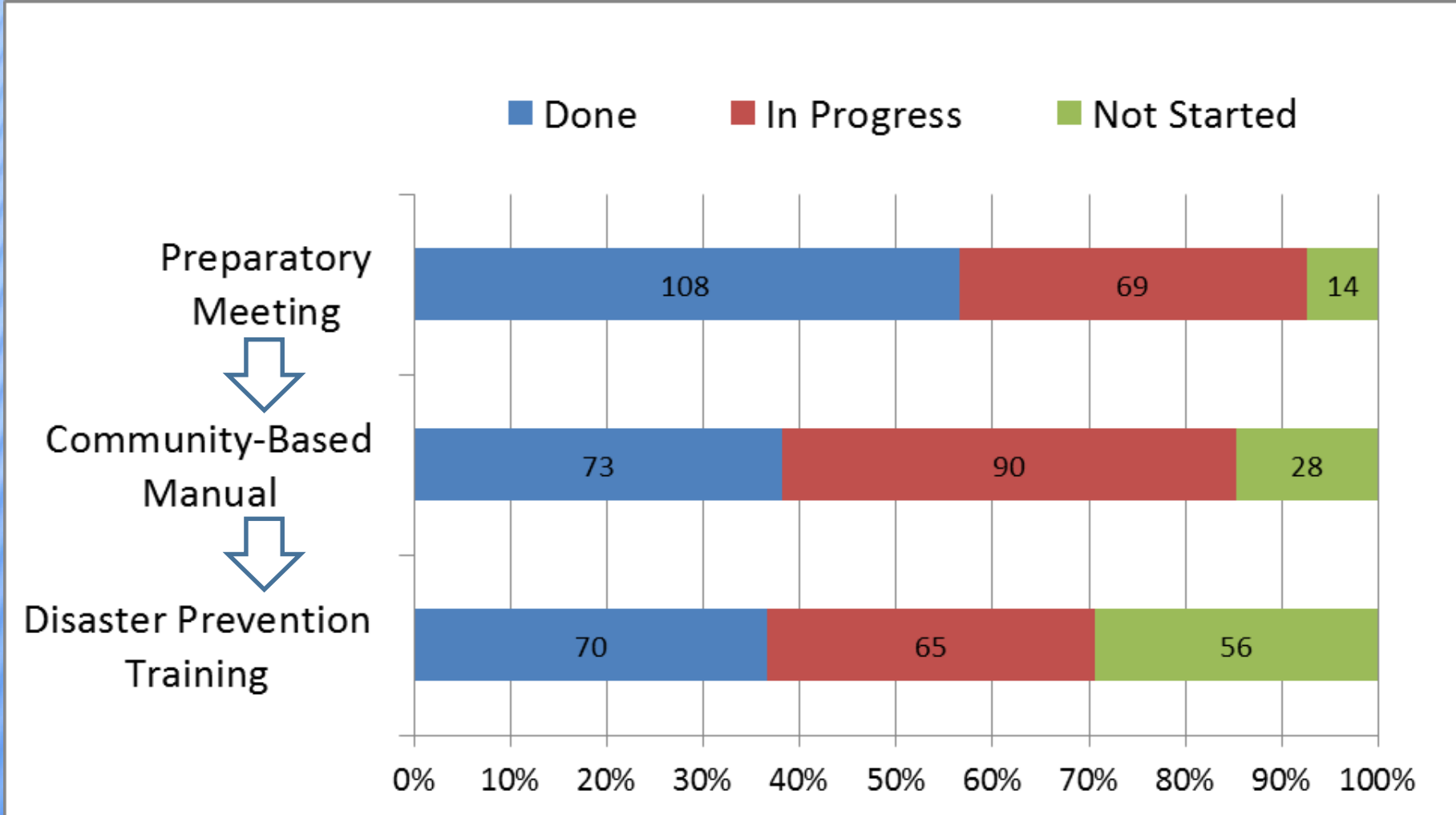

2 Acceleration on Disaster Prevention Act in SCWB

- PVC Pipeline Renovation
- Dual Transmission System
- Flex Exp. Joint Inspection & Repair Work
- Power Failure Measures
- ER Pipe Laying to Key Medical Institutions
- Temporary Emergency Tap → chapter3

Emergency Water Supply Facilities before Disaster

Reservoir with Cut Off Valve



Western Hillside area
20site

Temporary Emergency Tap on ER-Pipeline



Downtown area
24site

Under Ground Storage Tank

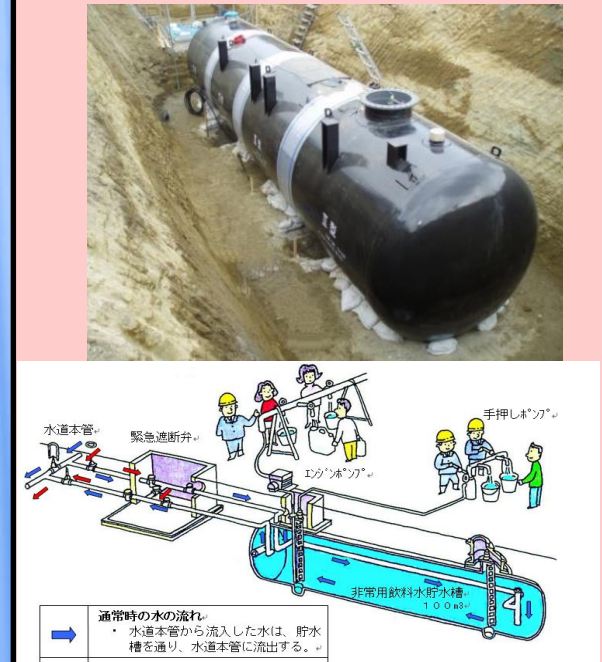

Eastern Plane area
21site

Emergency Water Supply Facilities **After Disaster**

Store at school

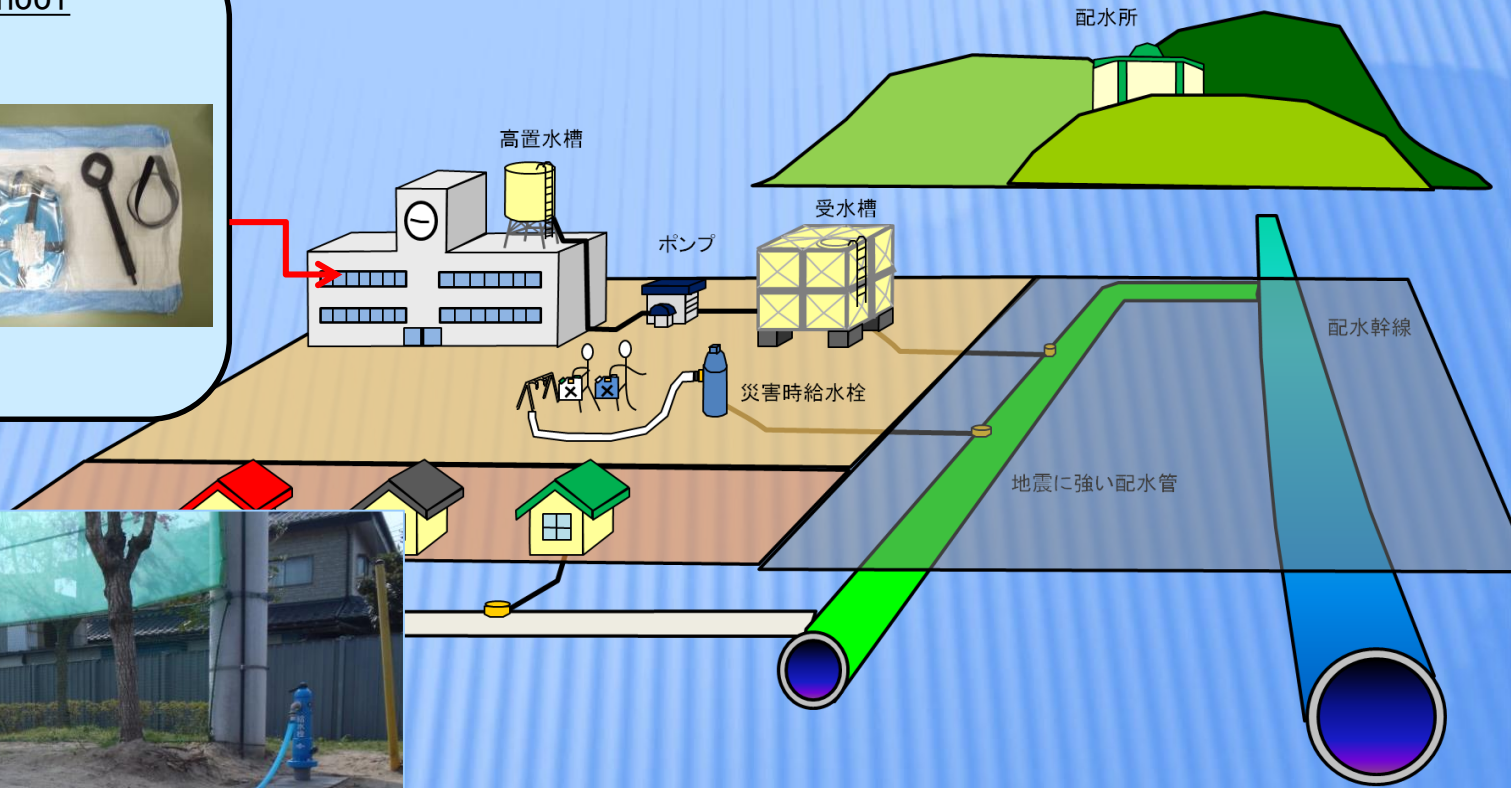

Training with Citizens



Thank you for Kind Attention.

Let's Have a LUNCH !



Sendai City Waterworks Bureau

